

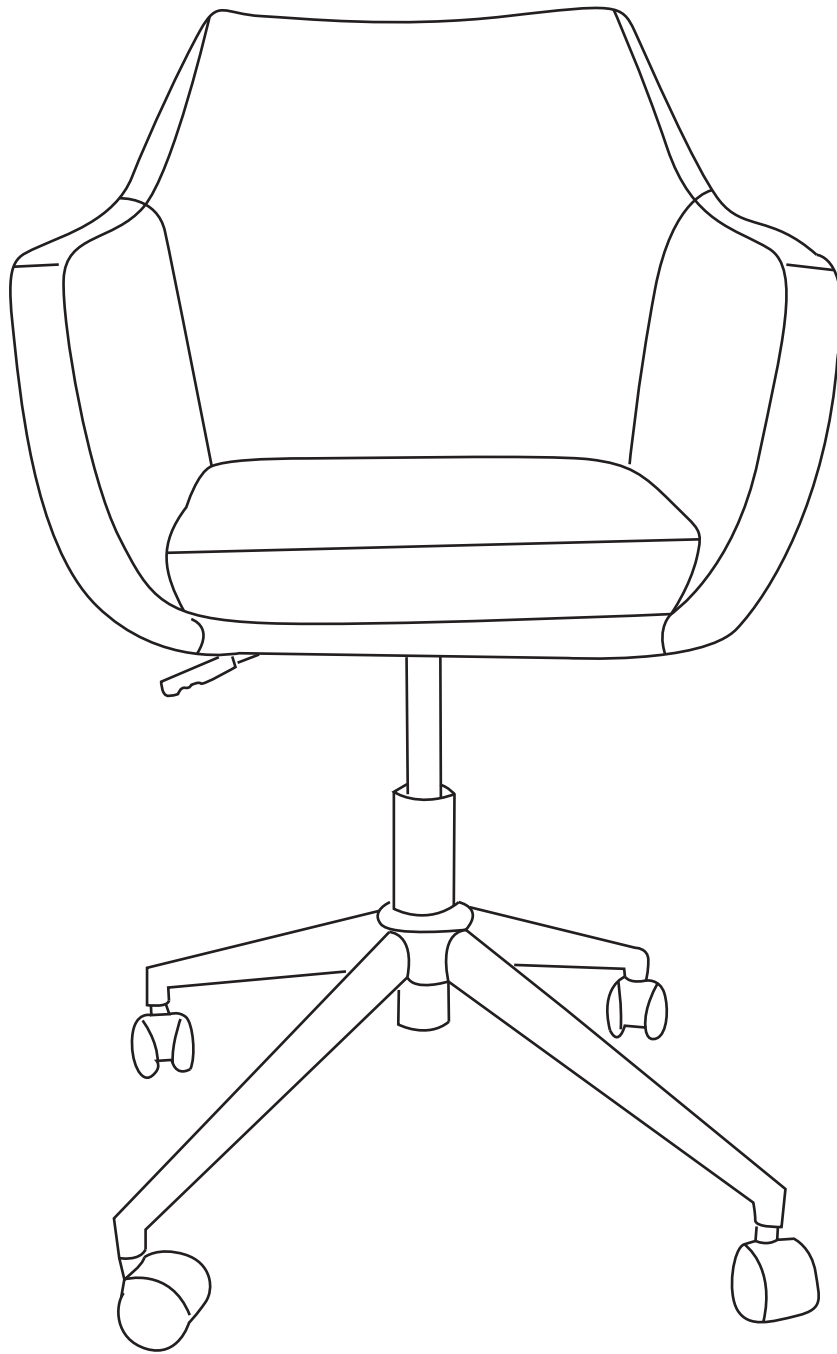











# Nora





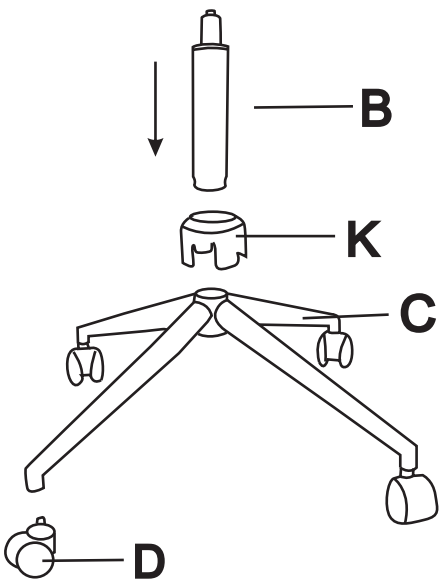

<b>Ax1</b> 	<b>Bx1</b> 	<b>Cx1</b> 	<b>Dx4</b> 	<b>Ex1</b> 	<b>Fx2</b>  M6X20	<b>Gx2</b>  M6X14	<b>Hx4</b>  6X18X1	<b>Ix2</b>  M11*25*3	<b>Jx1</b> 	<b>Kx1</b> 
--	---	---	---	---	--	--	---	---	---	---

1





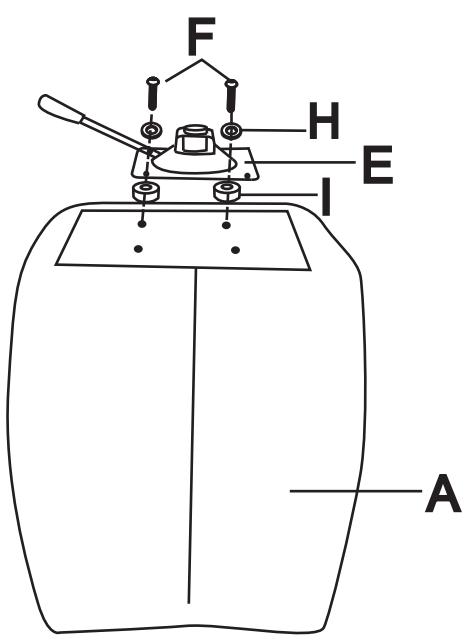

2

<b>Fx2</b>  M6X20	<b>Hx2</b>  M6X18X1	<b>Ix2</b>  M11*25*3	<b>Jx1</b> 
--	--	---	---

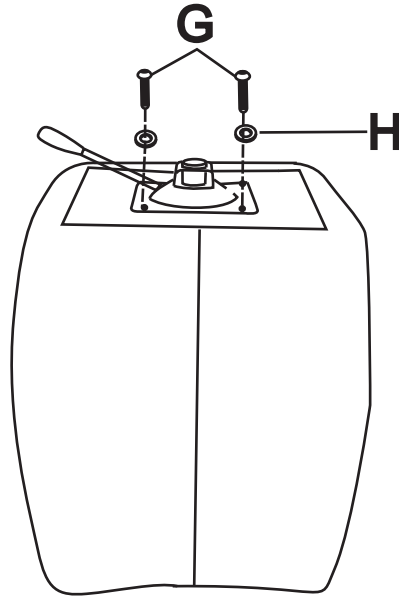

3



Gx2	Hx2	Jx1
		
M6X14	M6X18X1	

4

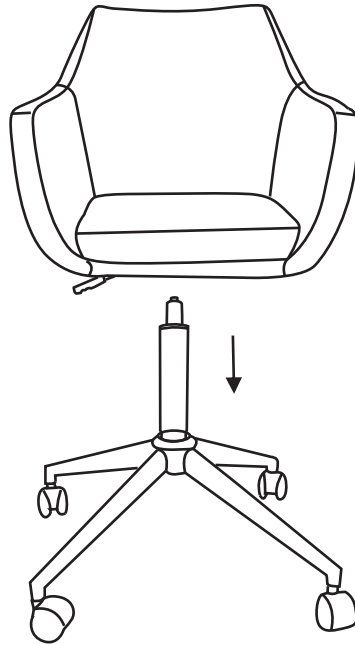

5

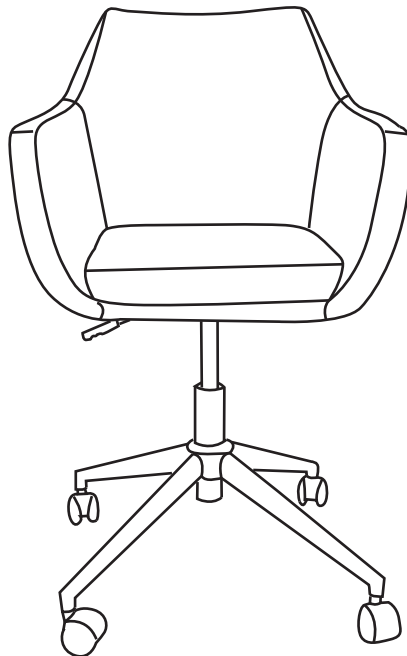

## **Obs!**

Dette produkt er udstyret med en standard fodsko.

Til bløde eller specielt skrøbelige og exclusive gulve, bør der anvendes en special fodsko, for at undgå trykmærker og/eller ridser.

Kontakt din møbelforhandler for yderligere oplysninger!

## **Please note!**

This product has been supplied with a standard foot cap.

For soft or specially fragile and exclusive floors we recommend to use a special foot cap in order to avoid pressure marks and/or scratches.

Please contact your furniture supplier for further information!

## **Bitte bemerken!**

Dieses Produkt ist mit einem standard Fußgleiter geliefert.

Für weiche oder spezial zarte und exclusive Fußböden empfehlen wir einen speziellen Fußgleiter, um Druckmarken und/oder Ritze zu vermeiden.

Bitte setzen Sie sich mit Ihrem Möbelhändler für weitere Informationen in Verbindung!

## **Atención**

Este producto está equipado con topes.

En caso de pisos blandos y frágiles, se debe de adquirir topes especiales para evitar marcas y/o rayaduras.

Por favor contactar su proveedor para mayor información

## **Avis important !**

Ce produit est équipé d'un embout standard.

Pour les parquets exclusifs qui sont mous et très fragiles, on doit utiliser un embout speciale pour éviter des marques et/ou des rayures.

Pour des renseignements supplémentaires contactez vôtre marchand de meubles.

